

Data Sheet



Article number: 0125054

Description: Retaining ring SP37
Spring steel

Measures

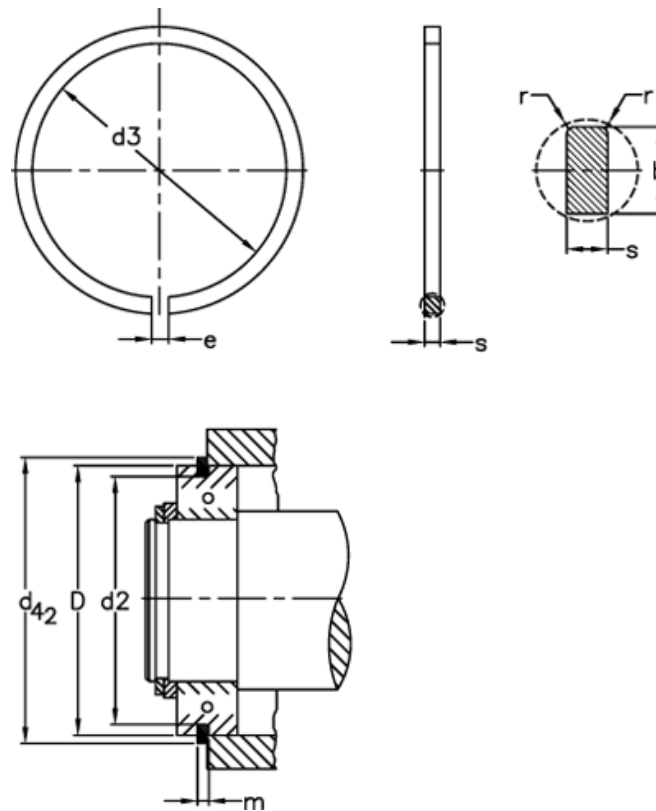

b	= 3.25	FRg kN	= 2.45	tol	= -0.15
D	= 37	FR kN	= 13.6	tol	= -0.1
d2	= 34.77	g	= 2.0	tol	= -0.25
d3	= 34.0	K kN-mm	= 26.6	tol	= 0.3
d42	= 41.3	m	= 1.35	tol	= 0.4
Description	= SP 37	n abl x 1000	= 10.0	Weight kg/1000	= 3.4
e	= 3	r min	= 0.4		
FN kN	= 20.7	s	= 1.12		